

# INSTRUCTION MANUAL

## INTERMATIC MULTIPURPOSE CONTROL

MECHANISM MODEL: P1353ME

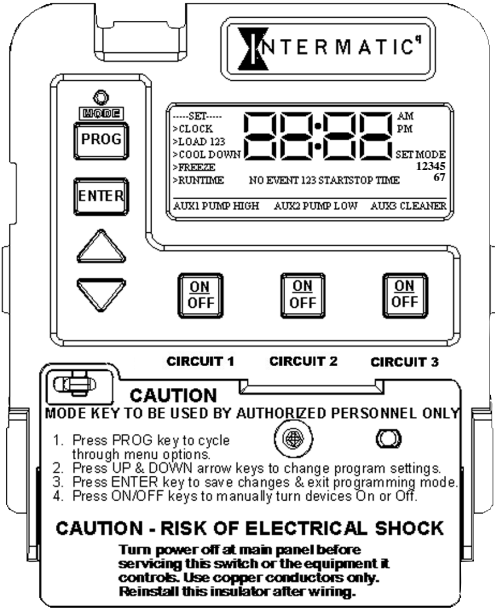

### ATTENTION

READ CAREFULLY BEFORE ATTEMPTING TO INSTALL YOUR INTERMATIC MULTIFUNCTION CONTROL SWITCH. FAILURE TO COMPLY WITH INSTRUCTIONS COULD RESULT IN PERSONAL INJURY AND/OR PROPERTY DAMAGE! RETAIN FOR FUTURE REFERENCE.

## Table of Contents

	Page
<b>Table Of Contents</b> .....	<b>2</b>
<b>Introduction</b> .....	<b>3</b>
<b>Warning and General Safety Information</b> .....	<b>4</b>
<b>Installation Tips &amp; Useful Information</b> .....	<b>5</b>
<b>Step #1 Identify Connections &amp; Voltage Selection</b> .....	<b>6,7</b>
<b>Step #2 Installing The Shutter Bushing</b> .....	<b>8</b>
<b>Step #3 Routing &amp; Connecting Low Voltage Accessories</b> .....	<b>9</b>
<b>Step #4 Snap In The Multipurpose Control</b> .....	<b>10</b>
<b>Step #5 Installing Corrugated Tubing</b> .....	<b>11</b>
<b>An Overview of the Multipurpose Control Panel</b> .....	<b>12,13</b>
<b>Mode Table</b> .....	<b>15</b>
<b>Step #6 Ratings, Wiring Schematics and Mode Selection</b> .....	<b>16 - 26</b>
<b>Rating for All Modes</b> .....	<b>16</b>
<b>Mode descriptions</b> .....	<b>17,18</b>
<b>Mode 1 (Aux1, Aux2, Aux3)</b> .....	<b>19</b>
<b>Mode 2 (Pump High, Pump Low, Aux3)</b> .....	<b>20</b>
<b>Mode 3 (Filter Pump, Aux2, Cleaner Pump)</b> .....	<b>21</b>
<b>Mode 4 (Pump High, Pump Low, Cleaner Pump)</b> .....	<b>22</b>
<b>Mode 5 (Pump L1, Pump L2, Aux3)</b> .....	<b>23</b>
<b>Mode 6 (Aux1, Aux2, Aux3)</b> .....	<b>24</b>
<b>Mode 7 (Pump High, Pump Low, Common)</b> .....	<b>25</b>
<b>Setting the Mode</b> .....	<b>26</b>
<b>Step#7 Setting The Time</b> .....	<b>27</b>
<b>Step#8 Setting The ON/OFF Times</b> .....	<b>28,29</b>
<b>Step#9 Setting The Cool Down Time</b> .....	<b>30</b>
<b>Step#10 Setting Freeze Protection</b> .....	<b>31</b>
<b>Display Definitions</b> .....	<b>32 - 34</b>
<b>Firemen Switch Runtime Display</b> .....	<b>32</b>
<b>Freeze Control Display</b> .....	<b>33</b>
<b>Cleaner Pump Display</b> .....	<b>34</b>
<b>Special Features</b> .....	<b>35 - 37</b>
<b>Setting the Countdown Timer</b> .....	<b>35</b>
<b>Viewing Revision Level</b> .....	<b>36</b>
<b>Clearing all ON/OFF Events</b> .....	<b>37</b>
<b>Warranty</b> .....	<b>39</b>

## 1-Year Limited Hardware Warranty

If within the warranty period specified, this product fails due to a defect in material or workmanship, Intermatic Incorporated will repair or replace, at its sole option, the unit free of charge. This warranty applies only to the original purchaser and is not transferable. This warranty does not apply to: (a) damage caused by accident, abuse, mishandling, dropping, acts of God, or any negligent use; (b) units which have been subject to unauthorized repair, opened, taken apart, or otherwise modified; (c) units not used in accordance with instructions; (d) damages exceeding the cost of the product. Some states do not allow a limitation of damages, so the foregoing limitation may not apply to you. This warranty gives you specific legal rights and you may have other rights that vary from state to state. INTERMATIC INCORPORATED WILL NOT BE LIABLE FOR INCIDENTAL OR CONSEQUENTIAL DAMAGES. THIS WARRANTY IS IN LIEU OF ALL OTHER EXPRESS OR IMPLIED WARRANTIES. ALL IMPLIED WARRANTIES, INCLUDING THE WARRANTY OF MERCHANTABILITY AND THE WARRANTY OF FITNESS FOR A PARTICULAR PURPOSE, ARE HEREBY MODIFIED TO EXIST ONLY AS CONTAINED IN THIS LIMITED WARRANTY, AND SHALL BE OF THE SAME DURATION AS THE WARRANTY PERIOD STATED ABOVE. This warranty service is available by either (a) returning the product to the dealer from whom the unit was purchased, or (b) mailing postage prepaid to the nearest authorized service center listed. Please be sure to wrap the product securely when mailing to avoid shipping damage. This warranty is made by: Intermatic Incorporated – After Sales Service, 7777 Winn Road, Spring Grove, Illinois 60081-9698 phone: (815) 675-7000

**AFTER SALES SERVICE – INTERMATIC INCORPORATED**

<http://www.intermatic.com>

7777 Winn Road, Spring Grove, Illinois 60081-9698



## WARNINGS AND GENERAL SAFETY INFORMATION

### **⚠ WARNING** *Risk of Fire or Electric Shock*

- Disconnect all power before installing or servicing this control or its connected loads.
- Follow all local electrical and safety codes, National Electric Code (NEC), as well as Occupational Safety and Health Act (OSHA).
- If the power disconnect point is out of sight, lock it in the "OFF" position and tag it to prevent unexpected application of power.
- The outdoor enclosure, in which the control is installed, must be grounded.
- Do not exceed the maximum current carrying capacity of this control.
- Always replace the plastic insulator covering the terminals before turning power "ON".
- Strip the line and load wires by removing 1/2 inch of insulation. **DO NOT USE ALUMINUM WIRE.** Insert the wire ends under the proper terminal plates and tighten the screws firmly. Use AWG #10 through #18. Use **COPPER** conductors only. Torque to 2-18 lbf-in.
- **DO NOT TOUCH** circuit board components; contact can create a static discharge, which can damage the microprocessor.
- **KEEP DOOR CLOSED AT ALL TIMES** when not servicing.

## Clearing all scheduled ON/OFF Events Quickly

To clear all schedules, follow the procedure below. This function is helpful when you want to start your event programming from scratch and disable all the current ON/OFF events.

1. Press and hold down the **PROG** key. The **display time** will blink

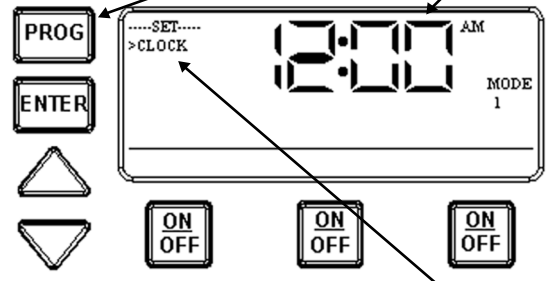

2. After approximately 5 seconds, the **SET CLOCK** will disappear and the display time will stop blinking.
3. You have now cleared all the scheduled ON/OFF events. Refer to step #8 to set new ON/OFF event times.

## Viewing the Software Revision Level

It may be necessary to view the revision level of the internal programming for service purposes, or compatibility issues with future Intermatic Designs. To do so, simply follow the below procedure:

1. Make sure the Multipurpose Control is not in programming mode. Press and hold down the **ENTER** key until the display changes.

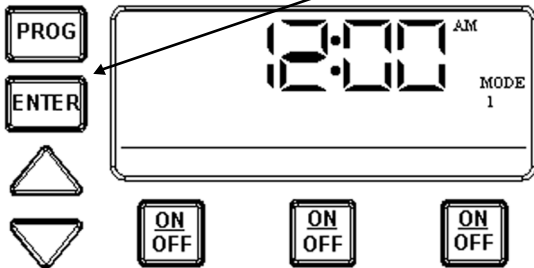

2. After 5 seconds, the display should change to the revision level. The **r1** stands for revision one, **r2** for revision two and so on.

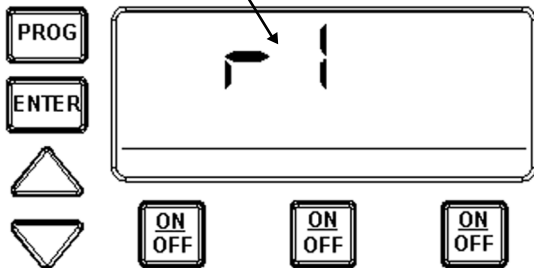

3. Release the **ENTER** key after viewing the revision level. The revision level should disappear and return back to the time of day.

## INSTALLATION TIPS & USEFUL INFORMATION

1. It's important to review, and install, all the possible low voltage accessories, (i.e. Firemen Switch, Remote Control, Freeze Probe), prior to installing the Multi-purpose Control into an Intermatic control center. Refer to pages 6 and 7 for further accessory details.
2. Each section of this installation manual is designed to be in the proper order of installation. It was designed this way to make your installation as easy as possible. Please follow each section carefully. Only skip sections that do not pertain to your particular installation.
3. It is important to set the Source Voltage Selector Jumper to the proper 120 VAC or 240 VAC position. Failure to set switch in proper position may blow F1 fuse and/or cause damage to circuit board voiding the manufactures warranty. Please refer to pages 6 and 7 for jumper information.
4. The "ON/OFF" keys are provided for service operations and for circumstances where instantaneous response is required. If the intent of this control is to turn equipment on and off everyday at the same time, programming individual events for each circuit will ensure these functions take place.
5. In the case of a power outage, all programmed events and parameters will stay in memory for 40 years. The time of day will be maintained for a maximum of 8 hours. If the power outage exceeds the 8-hour time limit, the clock will reset the time to 12 AM, and continue to implement the programmed events based on the new time of day. The new time will blink until changed.

## STEP #1 IDENTIFY LOW VOLTAGE ACCESSORY CONNECTIONS AND SET PROPER VOLTAGE SELECTION

**Freeze Probe Connection** – This connector is where you would connect the Intermatic Freeze Sensor Part Number 178PA28A (optional). It needs to be installed in order for the freeze protection circuit and programming to work. **Power needs to be disconnected when connecting the freeze sensor.** Only an Intermatic sensor will work with this controller. Refer to Page 31 for programming information.

**Heater Firemen Switch Connection** – This connector is where you would connect the two firemen switch wires that connect to the Pool/Spa heater. The installer supplies the wires and connectors. The connectors should be female spade connectors crimped to insulated type wire. This connection is a SPST contact that simply provides a switch closure for the Remote Activation Wires coming from the heater. It does not supply voltage to the heater thermostat. Refer to Page 30 for programming information.

## Special Features Setting The Countdown Timer

The countdown timer allows you to turn on a desired load for a predefined amount of time without interrupting or setting a new On/Off event. This feature is useful when chemicals are added to the pool or spa water, and the pump needs to circulate the chemicals for a minimum amount of time. You can define a countdown time for any or all of the three available circuits. The countdown time can range from 1 minute to 23 hours, 59 minutes. The countdown time will override all scheduled On/Off events for that particular circuit, and can only be cleared by manually turning off the circuit with the On/Off key.

1. Make sure the desired circuit you wish to enter a countdown time for is in the OFF position.
2. Choose the circuit you wish to enter a countdown for, in this case **Circuit #1**. Push and hold down its ON/OFF key, and at the same time push the up or down arrow to enter the **Runtime Mode**.

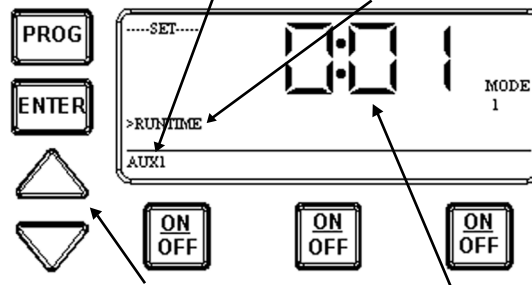

3. Use the **Up/Down keys** to change the **countdown time amount**, in this case 1 minute. Release the ON/OFF key when you have reached the desired countdown time. The circuit will now stay ON for the defined time entered.
4. If you desire to change the entered runtime, simply push and hold either the up or down arrow key, then push and hold the corresponding ON/OFF key. You can now use the arrow keys to modify the current runtime.

### Cleaner Pump Display

The cleaner pump **should always be connected to circuit #3** and the mode setting should be set to #3 or #4, depending on the filter pump configuration. Before the cleaner pump can come on, circuit #1 (filter pump) must be on for more than 30 seconds. If the filter pump is off and the cleaner pump must turn on because of a manual action or the beginning of a program, the control first forces the filter pump to go on, then 30 seconds later, turns the cleaner pump on. A **blinking cleaner pump icon** indicates the cleaner pump will start after the minimum 30-second delay.

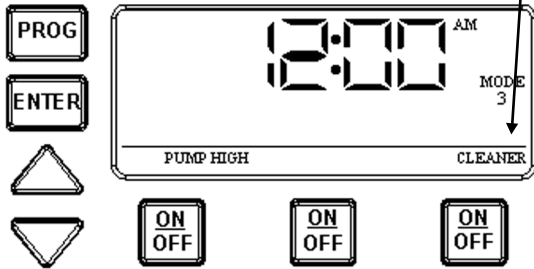

Like the other outputs, the cleaner pump icon is solid after the cleaner pump has turned on. In the event someone manually turns off the filter pump, the cleaner pump will also turn off.

If the control is connected to a two-speed pump, with a cleaner pump connected to circuit #3, the control should be in Mode 4. If the filter pump is off, or in low speed, and the cleaner pump must turn on because of a manual action or the beginning of a program, the control first forces the filter pump to turn on high speed, then 30 seconds later, turns the cleaner pump on.

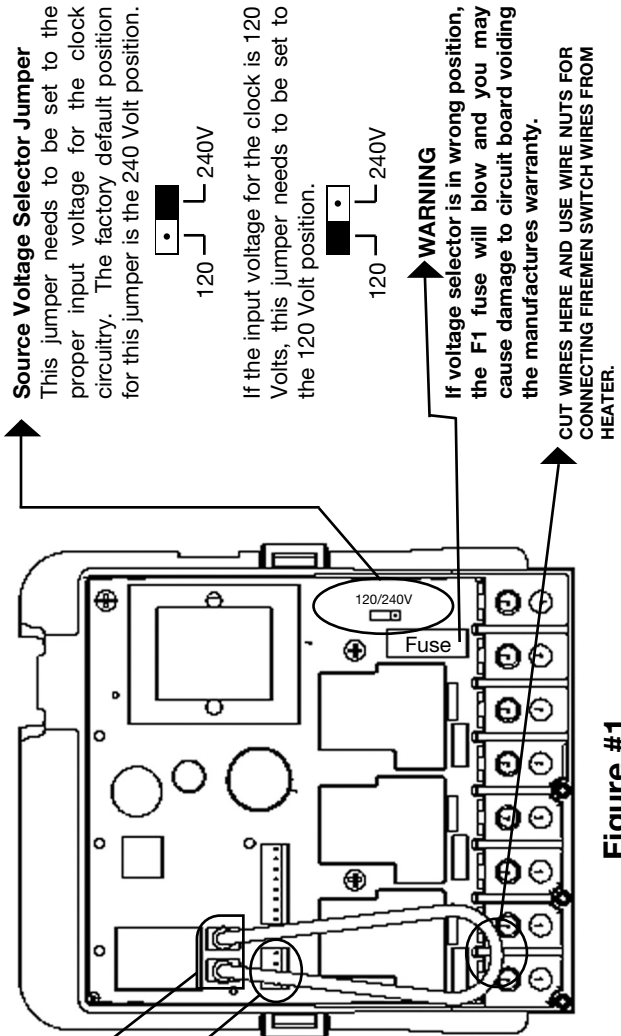

Figure #1

## STEP #2

### INSTALLING THE SHUTTER BUSHING

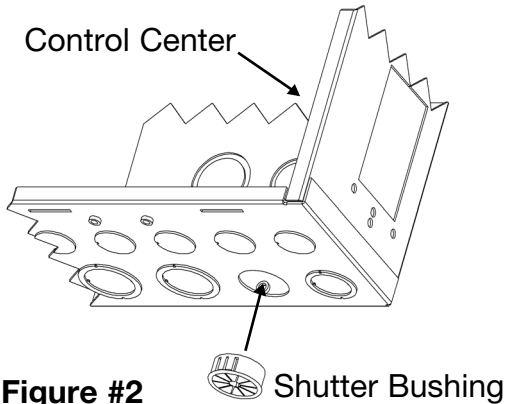

Figure #2 Shutter Bushing

## Installation Procedure

### IMPORTANT NOTE

*The shutter bushing needs to be installed if you intend to connect the Firemen Switch and/or Freeze Sensor accessories.*

1. Find any available 3/4" knockout.
2. Remove the knockout, and install the shutter bushing.

## Freeze Control Display

The following example illustrates how the display will look when the freeze protection feature is activated. In this example, the freeze sensor was connected, enabling the freeze protection feature. Circuits #1 & #3 were programmed to come on during a freeze condition.

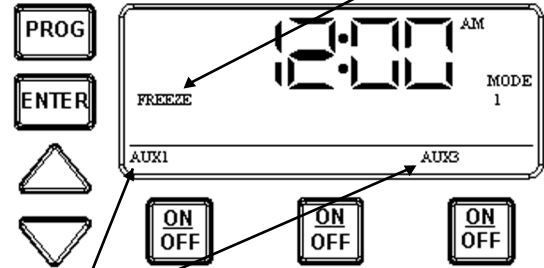

**Aux #1 & #3** will blink indicating the control has activated these two circuits due to a freeze condition. To override the circuits during a freeze condition, simply press and release each of the corresponding ON/OFF keys. This will override the freeze control and turn the devices OFF. The override will only last for one hour, so if the freeze condition still exists after one hour, circuits #1 & #3 will come back on.

The freeze protection stays enabled until the outside air temperature exceeds the pre-set temperature set point for more than one minute.

### IMPORTANT NOTE

The freeze protection feature will not work unless you have installed the freeze sensor probe. Refer to page 7 of this manual for ordering and installation instructions, and step #10 for freeze programming instructions.



## Display Definitions

### Cool Down (Fireman Switch) Runtime Display

The following example illustrates how the display will look when the cool down feature is activated. In this example, the cool down time was set for 5 minutes, and is in the process of **counting down** to zero, showing **minutes and seconds**.

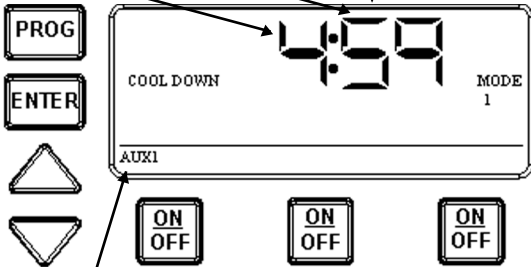

The **AUX1 indicator is blinking** indicating the cool down feature is activated for circuit #1. When the count down display reaches **zero**, the actuated circuits (#1 or #2) depending on mode (2 or 4), will open and the display will change back to the time of day.

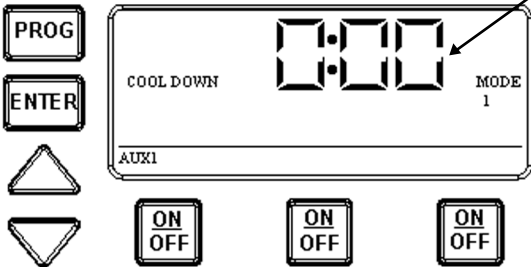

You can override the cool down feature by simply pressing and releasing the ON/OFF key associated with circuit #1. This will end the cool down cycle, and immediately turn off circuit #1.

## STEP #3 ROUTE ACCESSORY WIRES AND CONNECTORS INTO ENCLOSURE AND CONNECT TO THEIR PROPER LOCATIONS

### Installation Procedure

- 1 Push the Fireman Switch wires and/or the Freeze Sensor Cable through the installed Shutter Bushing and into the control center. Connect these accessories to the back of the multipurpose control mechanism (See Figure #1 for connector locations).

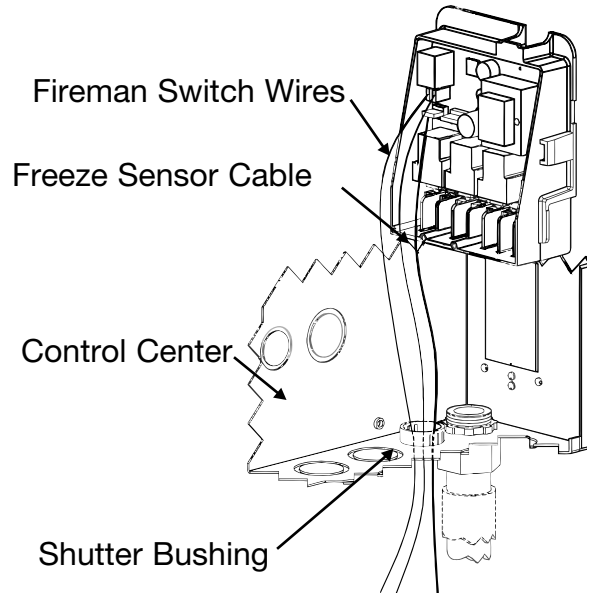

Figure #3

## STEP #4 SNAP THE MULTIPURPOSE CONTROL INTO THE INTERMATIC PANEL

### IMPORTANT NOTE

Since you have easy access to the back of the Multipurpose Control, make sure you properly set the source voltage selector jumper to the voltage (i.e. 120V or 240V), you intend to use for powering the Multipurpose Control. This jumper is located on the back of the control (See Figure #1 for location and setting).

## Installation Procedure

1. Rotate the Multipurpose Control mechanism until the Tabs line up with the Slots. Slide the bottom half in the Slots, and push the top half into the Bracket until the mechanism snaps into the Bracket Slot.

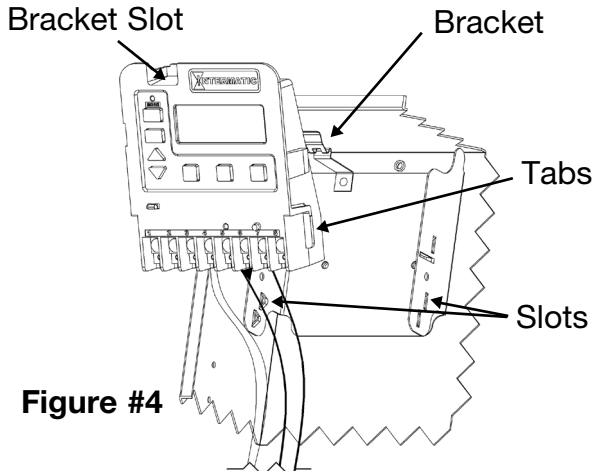

Figure #4

## STEP #10 Setting Freeze Protection

### NOTE

The freeze protection programming will not appear unless you have installed the Intermatic freeze sensor, (See Fig. #1 for installation and ordering details). Without the freeze sensor installed, programming will end once you have finished programming the cool down cycle, and pressed and released the Program key to advance.

1. Use the program key to save and advance to the Freeze setting.

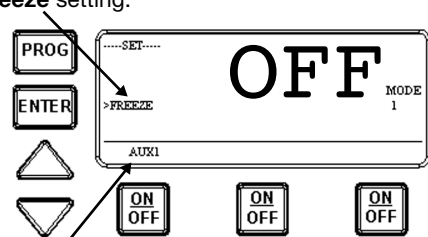

The 1st circuit is the factory selected default.

2. Use the Up and Down arrow keys to switch between Freeze Protection ON and OFF.
3. Push and release the desired ON/OFF keys to indicate which circuits should come ON when freeze protection engages.
4. When programming is complete, push and release the Enter key or Program key to end your programming session.

If the clock has freeze protection turned ON and the probe goes bad or the cable is cut/removed, the pump will turn on and continue to run as if a freeze condition exists. Preselected circuits will activate and FREEZE will be displayed. At this point, the time switch **stops** running the programmed schedule. To restore normal operation the probe must be replaced.

To temporarily restore normal operation press the ON/OFF button for the circuit(s) that is active. "Freeze" will begin to flash to indicate that freeze protection is over ridden and the clock will follow the programmed schedule. (NOTE: if there is a power outage, when power is resumed the clock will go back into freeze mode).

## STEP #9

### Setting The Cool Down Time (Fireman Switch)

### NOTE

The cool down time is a time defined by the programmer. It's used in conjunction with a pool heater, (See Fig. #1 for heater hookup), and it's defined as the additional time the pump will run over and beyond the desired pump OFF time with the Fireman switch open. If a time is programmed, the cool down cycle will occur in all cases, even if the user turns off the pump. To override the cool down time, simply press and release the ON/OFF key a **second time** during the cool down cycle. **NOTE:** The cool down feature applies to circuit #1, only in modes 1/3/5/6. In modes 2/4/7 either circuit #1, or circuit #2 will activate the cool down feature.

1. Use the **PROG** key to advance to the **Cool Down** setting.

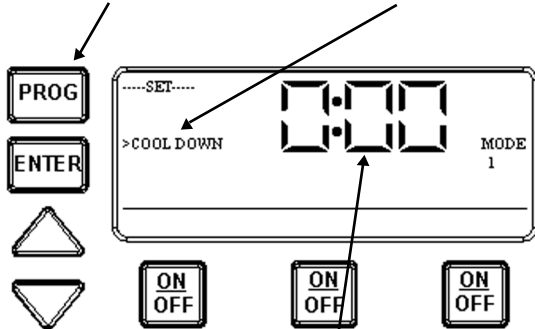

2. The default cool down time is zero. Use the arrow keys to modify the cool down time. The range is zero to fifteen minutes. Use the Enter key or Program key to either save and exit, or save and advance to the next programming feature.

## STEP #5

### CUT & INSTALL TUBING OVER THE LOW VOLTAGE ACCESSORY WIRES AND/OR CORDS

1. The installation of the corrugated tubing kit (part of mechanism), Part Number 156PA12927A is necessary in order to create a double barrier of insulation between the low voltage accessory wires and high voltage line and load wires.
2. Secure the tubing using the cable ties and self-adhesive retainers supplied with the tubing kit.

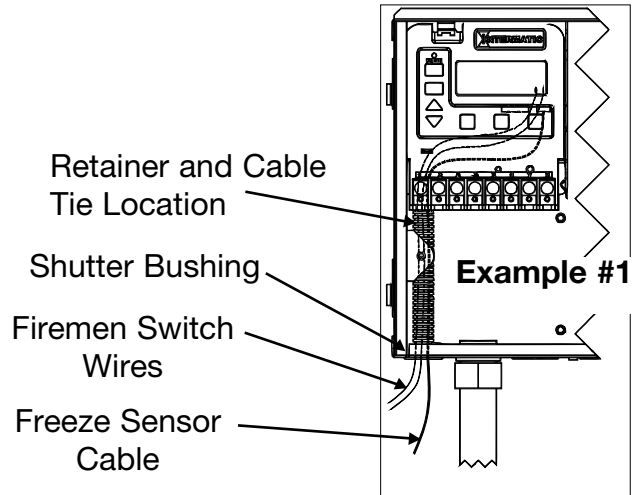

## AN OVERVIEW OF THE MULTIPURPOSE CONTROL PANEL

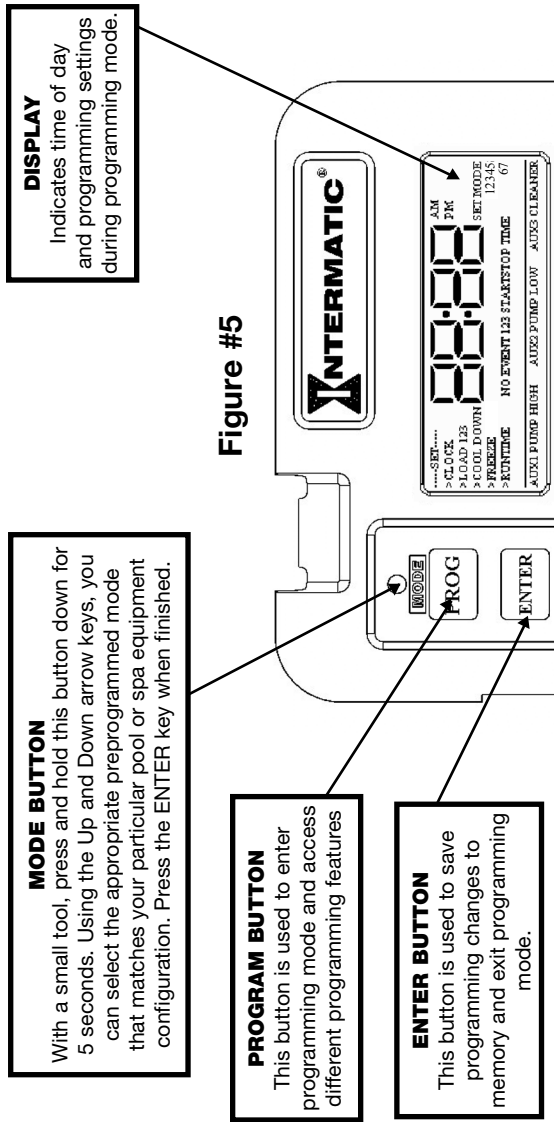

12

- Once you are satisfied with the start time, press and release the Enter Key. You have now saved the start time, and the display will prompt you for the desired **Stop time** for circuit #1's 1st event.

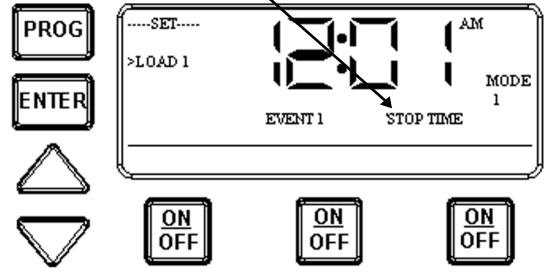

- Use the Up and Down arrows keys to define the stop time for circuit #1's 1st event. Press and release the Enter key when complete. The program will now advance to the **second event** for circuit #1.

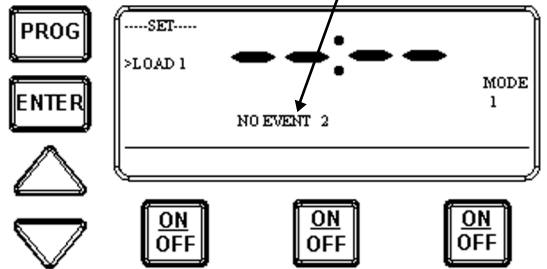

- The display indicates, no 2nd event for circuit #1 has been defined. Follow the previous tasks 2 thru 4 to set a second event for circuit #1.

### NOTE

*The ENTER key can be used to review all the events for each circuit. The program key will advance you through each circuit and onto the next programming feature.*

29

## STEP #8

### Setting On/Off Times for Each Circuit

- If you pressed and released the program key from the previous procedure, you should see the following display, if not, press and release the program key **twice** to get to the following display. The display is defined as:

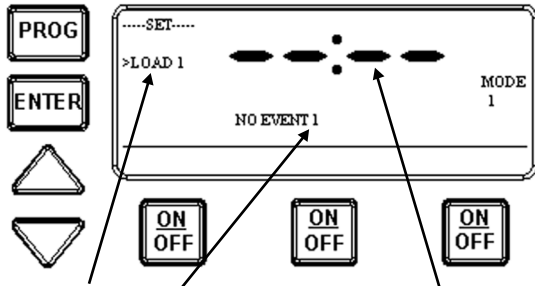

**Circuit #1's first event has not been defined.** You have the ability to program up to three separate events per load or circuit. An event is defined as a complete On and Off cycle.

- Use the Up and Down arrow keys to define the **Start time for circuit #1's 1st event.**

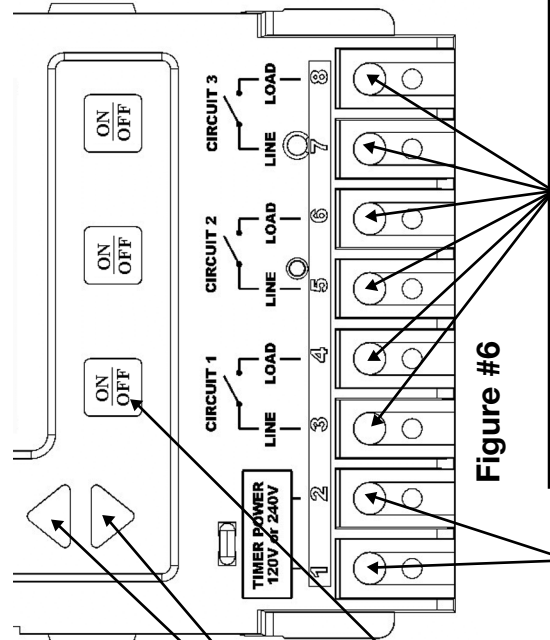
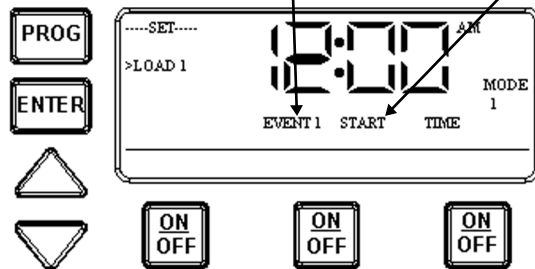

**Figure #6**

#### CIRCUIT 1, 2 & 3

These six terminals are where you wire your equipment source voltage and equipment load lines. You can have different source voltages for each circuit, depending on your equipment requirements.

#### ARROW BUTTONS

These buttons are used to increase or decrease programming parameters when in programming mode.

#### ON/OFF BUTTONS

Turns on and off circuit functions.

#### TIMER POWER

These two terminals are where you wire 120V or 240V to power the multipurpose control. Be sure the jumper on the back, matches the source voltage. See Pg. 6&7

## STEP #7

### Setting The Time

1. Press and release the **program key**. The **displayed time** will start to blink, and the **program menu** will display Set Clock.
2. Use the **Up and Down arrows** to change the time. Take note of the **AM and PM indicator** when setting time.
3. When desired time is indicated, either press and release the Enter key to save and exit programming, or press and release the program key to save and go on to the next programming feature.

Page intentionally left blank

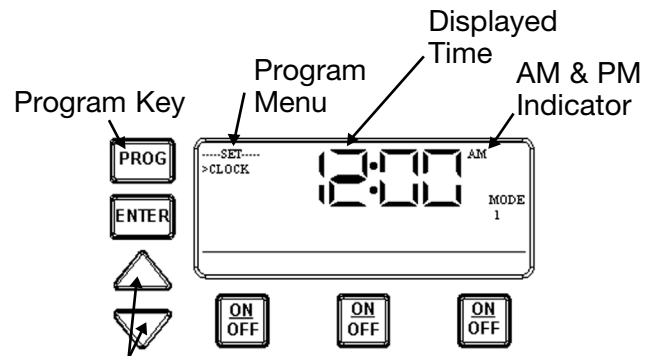

Up and Down Arrows

#### IMPORTANT NOTE

*When in programming mode, if none of the available keys are pushed within 60 seconds, the multi-purpose control will save all settings and return back to normal operating mode.*

## Setting The Mode

1. With a small blunt instrument, press and hold the **Mode Button** (Approximately 5 seconds) until the display shows **SET MODE** and the **Mode Number** blinks.
2. Use the Up and Down **arrow keys** to cycle through all available modes. Each **circuit output will be defined** as you cycle through the available modes.
3. Once the desired mode number is displayed, press and release the **ENTER key**. This saves it to memory and exits the set mode programming.

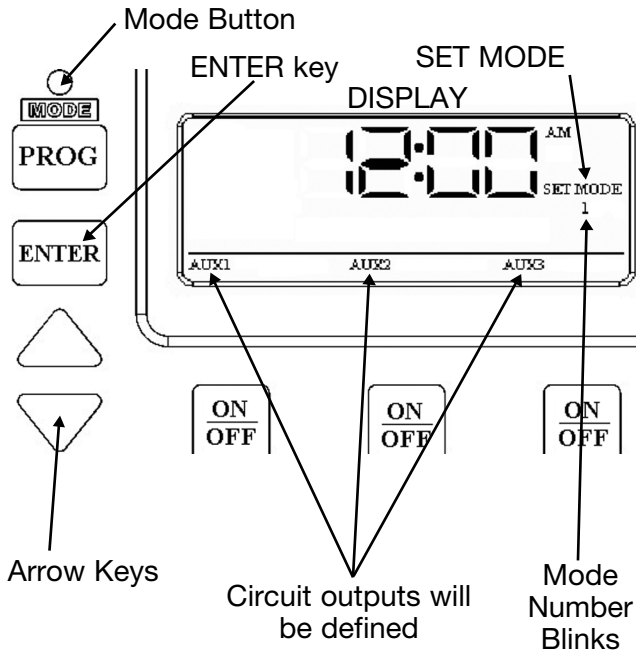

## IMPORTANT NOTE

You should have now completed installing the Intermatic Multipurpose Control and available accessories. Prior to wiring the equipment to the control, you should read and understand Step #6, which clearly defines the individual circuit ratings, available mode settings and their relative wiring diagrams. Below is a quick reference Mode Table. This will help you to quickly identify each possible circuit output. Refer to Step #6 for a more complete definition.

MODES OF OPERATION			
MODE SELECTION	CIRCUIT #1	CIRCUIT #2	CIRCUIT #3
CHOOSE MODE 1 TO CONTROL ANY THREE INDEPENDENT LOADS			
MODE 1	AUX 1	AUX 2	AUX 3
CHOOSE MODE 2 TO CONTROL A TWO-SPEED PUMP AND ONE INDEPENDENT LOAD			
MODE 2	PUMP HIGH	PUMP LOW	AUX 3
CHOOSE MODE 3 TO CONTROL A SINGLE SPEED PUMP WITH A CLEANER PUMP AND ONE INDEPENDENT LOAD			
MODE 3	PUMP	AUX 2	CLEANER PUMP
CHOOSE MODE 4 TO CONTROL A TWO-SPEED PUMP WITH A CLEANER PUMP			
MODE 4	PUMP HIGH	PUMP LOW	CLEANER PUMP
CHOOSE MODE 5 TO CONTROL TWO INDEPENDENT DEVICES WHERE ONE DEVICE REQUIRES BOTH POWER LEGS TO BE DISCONNECTED			
MODE 5	PUMP L1	PUMP L2	AUX 3
CHOOSE MODE 6 TO CONTROL THREE INDEPENDENT LOADS. FIREMAN'S SWITCH WILL CLOSE ONLY WHEN CIRCUIT IS MANUALLY TURNED ON.			
MODE 6*	AUX 1	AUX 2	AUX 3
CHOOSE MODE 7 TO CONTROL A TWO-SPEED PUMP WHERE BOTH POWER LEGS ARE REQUIRED TO BE DISCONNECTED			
MODE 7	PUMP HIGH	PUMP LOW	COMMON

\*Circuit 1 will circulate pool or spa without heating body of water.  
**NOTE:** Auxiliaries can be used to control any piece of equipment.

# STEP #6

## MULTIPURPOSE CONTROL

### RATINGS, WIRING AND SETTING THE MODE

#### IMPORTANT NOTE

*There are seven modes to choose from depending on your pool or spa equipment configuration. Each mode has specific programming, timing, and lockout features that are designed to work with specific types of pool or spa equipment. Mode setting is generally done only once and usually during the initial installation. It is purposely difficult to enter the mode-changing program and should only be done by a Qualified Installer. Be sure you fully understand each mode's definition and installation, prior to selecting the proper mode.*

#### Control Ratings and Individual Circuit Ratings

**CLOCK SOURCE VOLTAGE:** 120/240V AC, 50/60 Hz.  
**POWER CONSUMPTION:** 6W Max.  
**CONTACT CONFIGURATION:** SPST – each circuit

#### CONTACT RATINGS – EACH CIRCUIT, ALL MODES:

- 17A Resistive, 120/240V AC
- 17 FLA, 80 LRA 120/240V AC
- 5A Tungsten, 120/240V AC

**EVENTS PER CIRCUIT:** 3 On/Off Events Per Circuit

#### MEMORY RETENTION:

- 40 Year retention for all programmed settings
- 8-hour time retention

#### CLOCK CIRCUIT PROTECTION:

- Fast acting type 5x20, 125 mA Fuse

**Mode 7 – (Pump High, Pump Low)** Circuit one and two are dedicated single pole outputs for a two-speed pump load. Circuits one and two will never be ON at the same time. Circuit three works together with either circuit one or circuit two to provide the capability of removing both power legs (L1 & L2) from the pump in a 240 VAC installation. If circuit one is activated, circuit three activates at the same time. Likewise for circuit two, when activated, circuit three activates.

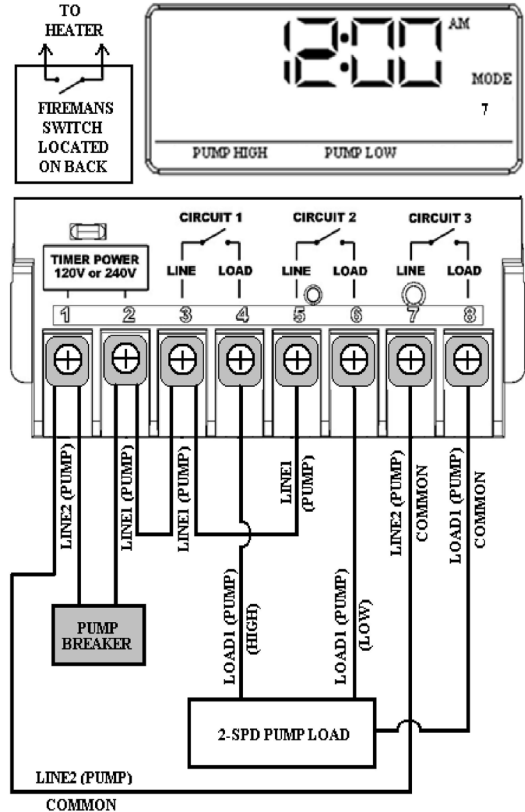



**Mode 6** – (Aux1, Aux2, Aux3) Each of the three single pole circuits are defined generically, and can control any load within each of its individual circuit ratings. All three circuits act independent of each other. The fireman switch closes when circuit one is activated manually by the user and opens when the user manually turns OFF circuit one. The fireman switch remains open when circuit one is activated by a programmed time event.

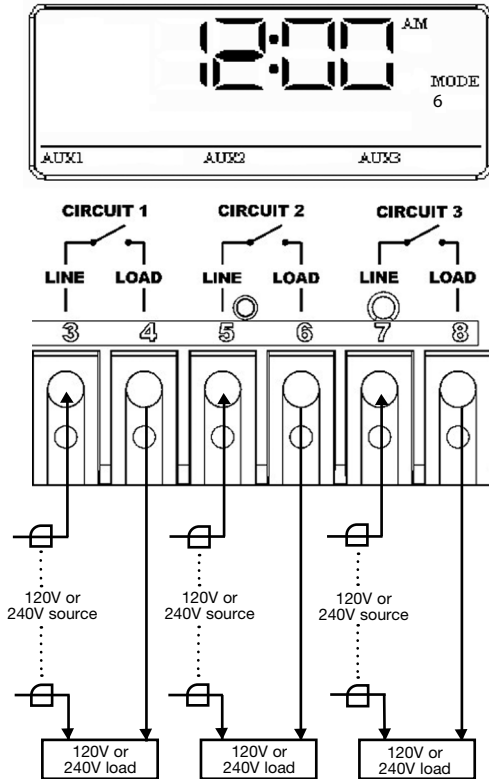

### IMPORTANT NOTE CONCERNING SETTING THE ON/OFF TIMES FOR EACH MODE

1. The “ON/OFF” keys are provided for service operations, and for circumstances where instantaneous response is required. If the intent is to turn equipment on and off everyday at the same time, programming individual events will ensure these functions take place.
2. All circuits will respond to a programmed off time. Therefore, when a circuit is turned on with the “ON/OFF” key, it automatically turns itself off at the end of the next programmed event.
3. If there are no events programmed, the circuit stays on until the “ON/OFF” key is pressed again.
4. If the “ON/OFF” key is pressed while the corresponding circuit is on, it turns the circuit off and supersedes any program in progress. The priority is always given to the last manual operation.

**MODE 1** – (Aux1, Aux2, Aux3) All three of the available circuits act independently, and up to three individual on/off times can be set for each circuit independently.

**MODE 2** – (Pump High, Pump Low, Aux 3) In this mode circuits 1 & 2 are connected to a two speed pump, and Aux 3 is connected independent of circuits 1 & 2. In the event, you program high and low speed to be on at the same time, or the independent ON times overlap, high speed will always take precedence.

Example: Low speed is programmed to come ON at noon and run until 6 PM. High speed is programmed to come on at 2 PM and turn off at 4 PM. In this case the pump will come ON at noon in low speed, go to high speed at 2 PM, and back to low speed at 4 PM, and shut off at 6 PM.

All manual ON operations for circuits 1 & 2 override all programmed ON times. Therefore, any desired low and high-speed run combinations need to be programmed as separate events and not controlled by combining the manual ON/OFF key with a scheduled event. The last speed started manually has priority over all prior automatic and manual operations.

Example: You would like to run the pump in high speed for 6 hours and low speed for the remainder of the time. Program a 6-hour event for high speed, and an 18-hour event for low speed. Do not turn the low speed on manually, and program a 6-hour event for high speed. The high speed will not occur.

**MODE 3** – (Filter Pump, Aux2, Cleaner Pump) Since the cleaner pump cannot turn on unless the filter pump has been on for at least 30 seconds, anytime an ON/OFF time is programmed for the cleaner pump the filter pump will come on first and 30 seconds later the cleaner pump will turn on. Both the cleaner and filter pump will turn off according to the programmed off time. When programming an event for the cleaner pump, it is not necessary to program a separate event for the filter pump, as it will automatically turn on when the cleaner pump turns on at its next scheduled on time.

**MODE 4** – (Pump High, Pump Low, Cleaner Pump) This mode is a combination of modes 2 and 3; therefore refer above to modes 2 & 3 for programming specifics. If the cleaner pump is programmed to come ON, the control will turn ON the filter pump to high speed 30 seconds prior to turning the cleaner pump ON, even if the filter pump is currently on in low speed.

**MODE 5** – (Pump L1, Pump L2, Aux3) The time switch is a 2-circuit switch with the 1st and 2nd switch controlling a 240V pump where both power legs, L1 and L2, are required to be disconnected when the pump is OFF. The 3rd switch is controlling any auxiliary device.

**MODE 6** – (Aux1, Aux2, Aux3) Identical to Mode 1, but provides the ability to run a heater when only the filter pump is manually turned on. Therefore, the heater will not activate with the programmed filter schedule.

**MODE 7** – (Pump High, Pump Low, Common) Identical to Mode 2, with the capability to break both hot lines of a 240 VAC two-speed pump connection. Circuit 1 connects the High line and circuit 2 connects the Low line of a two-speed pump and a 3rd circuit connects the common hot line. This mode also provides two-speed pump timing and protection.

**Mode 5** – (Pump L1, Pump L2, Aux3) Circuit one and two are now coupled together making up one circuit capable of switch both poles of a power source. The On/Off button for circuit one now controls both circuit one and two simultaneously. The On/Off button for circuit two is disabled. Circuit three remains a single pole circuit for a generic load, and is independent of circuits one and two.

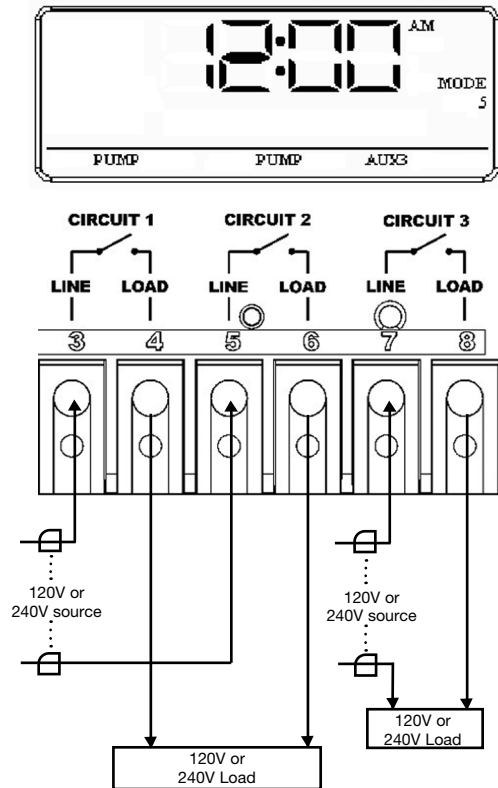

**Mode 4** – (Pump High, Pump Low, Cleaner Pump)  
 Circuit one and two are dedicated single pole outputs for a two-speed pump load. Circuits one and two will never be ON at the same time, consistent with a two-speed pump application. Circuit three is also a dedicated single pole output for a pressure side cleaner pump. Circuit three will never come on unless circuit one is on for at least one minute, consistent with a pressure side cleaner pump.

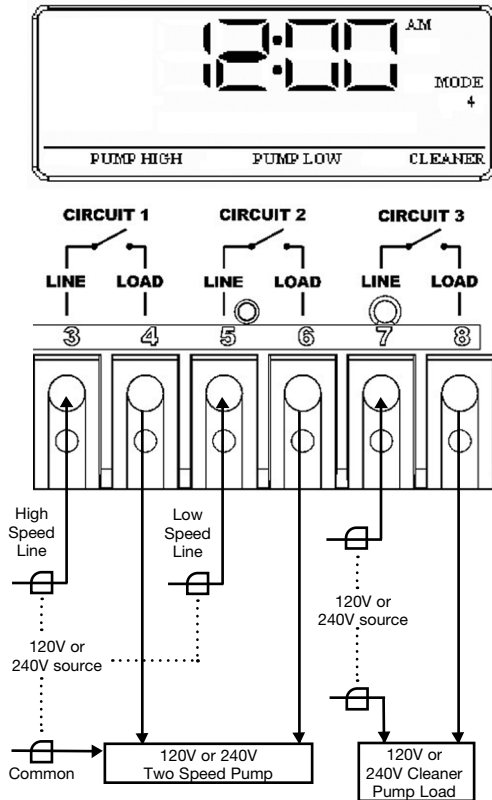

### Defining & Wiring Each Mode

**Mode 1** – (Aux1, Aux2, Aux3) Each of the three single pole circuits are defined generically, and can control any load within each of its individual circuit ratings. All three circuits act independent of each other.

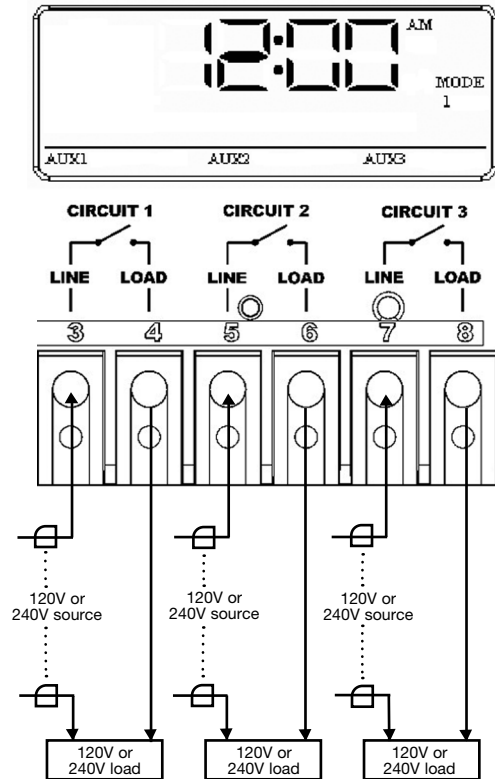

**Mode 2** – (Pump High, Pump Low, Aux3) Circuit one and two are dedicated single pole outputs for a two-speed pump load. Circuits one and two will never be ON at the same time, consistent with a two-speed pump application. Circuit three is single pole circuit for a generic load, and independent of circuits one and two.

**Mode 3** – (Pump, Aux2, Cleaner Pump) Circuit one and three are dedicated single pole outputs for a single speed pump working with a pressure side cleaner pump. Circuit three will never come on unless circuit one is on for at least one minute, consistent with a pressure side cleaner pump. Circuit two is a single pole circuit for a generic load, independent of circuits one and three.

